



GALLERIA DI BASE DEL BRENNERO BRENNER BASISTUNNEL BBT-SE

ING. RAFFAELE ZURLO

FRANZENSFESTE/FORTEZZA

19.04.2018



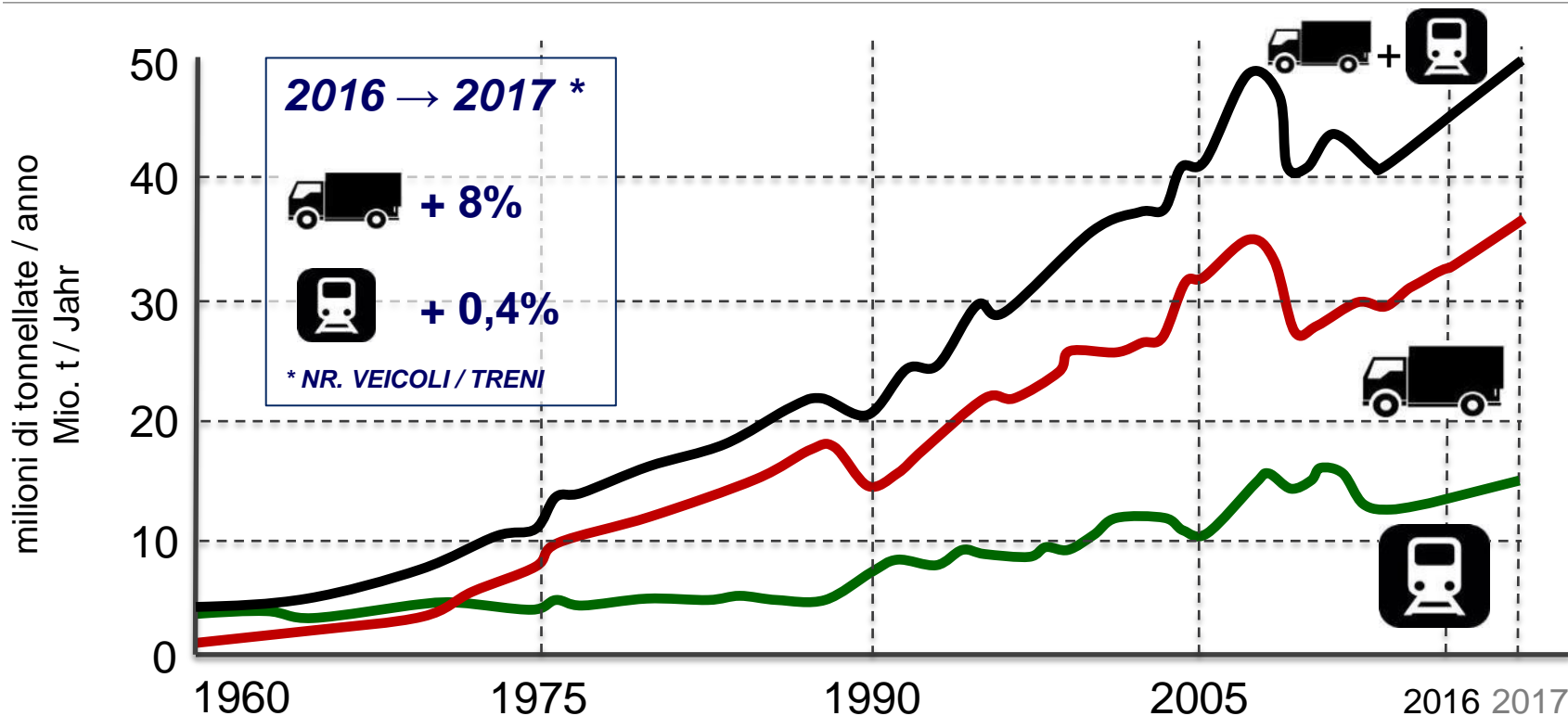

Von der Europäischen Union kofinanziert
Fazilität „Connecting Europe“
Cofinanziato dall'Unione europea
Meccanismo per collegare l'Europa

IL TRASPORTO MERCI AL BRENNERO *DER WARENVERKEHR AM BRENNNER*



IL TRACCIATO *DIE STRECKENFÜHRUNG*



-  Linea storica / Bestandsstrecke
-  Nuovo tracciato / Neubaustrecke

IL PROFILO LONGITUDINALE

DAS LÄNGSPROFIL



Höhe (m ü. d. M.)
altitudine (m s.l.m.)

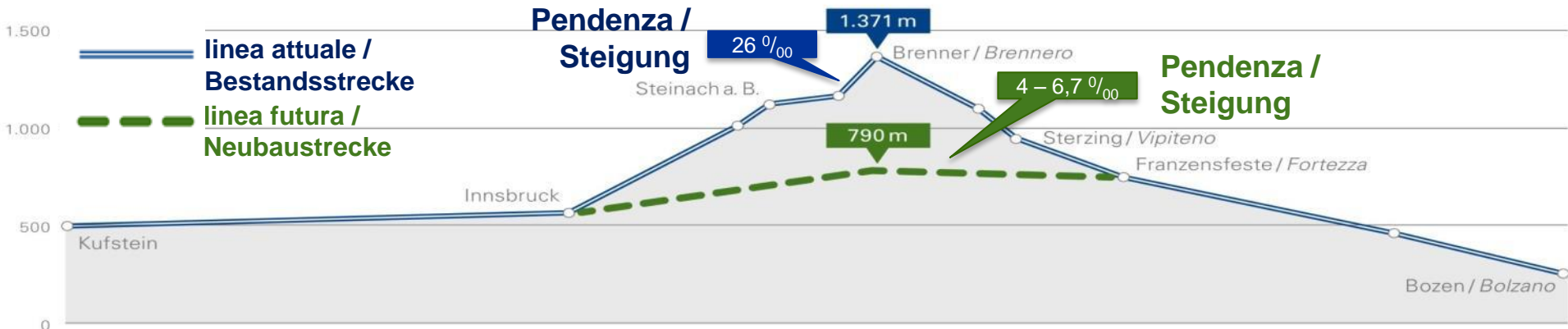

Treni merci Güterzüge	Lunghezza linea Streckenlänge	Locomotori Lokomotiven	Lunghezza treni Zuglänge	Massa rimorchiabile Zuglast	Peso per asse Achslast	Percorrenza (merci) Fahrzeit (Güter)	Percorrenza (passeggeri) Fahrzeit (Personen)
Linea attuale Bestandsstrecke	75 km	2 - 3	450 m	1200 t	22,5 ton	1h 45'	1h 20'
Linea futura Neubaustrecke	55 km	1	750 m	1600 t	25 ton	35'	25'

LA SEZIONE DER QUERSCHNITT



Haupttunnel 1
Galleria principale 1
Ø 9,00m

Brenner Basistunnel

Innsbruck – Franzensfeste: 55 km
Tulfes – Franzensfeste: 62,7 km
Neigung: 4 – 6,7 ‰

Galleria di Base del Brennero

Innsbruck – Fortezza: 55 km
Tulfes – Fortezza: 62,7 km
Pendenza: 4 – 6,7 ‰

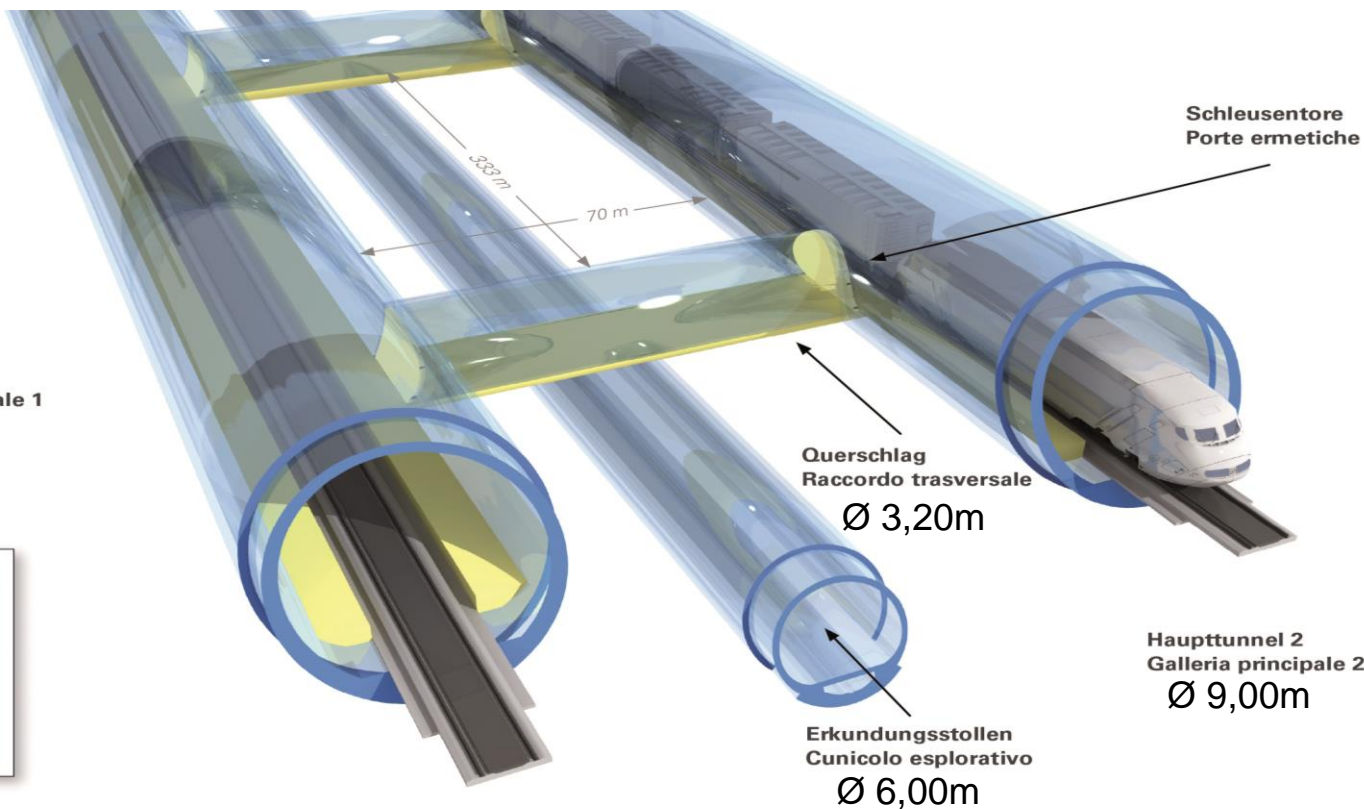

PROGRAMMA LAVORI DAS BAUPROGRAMM

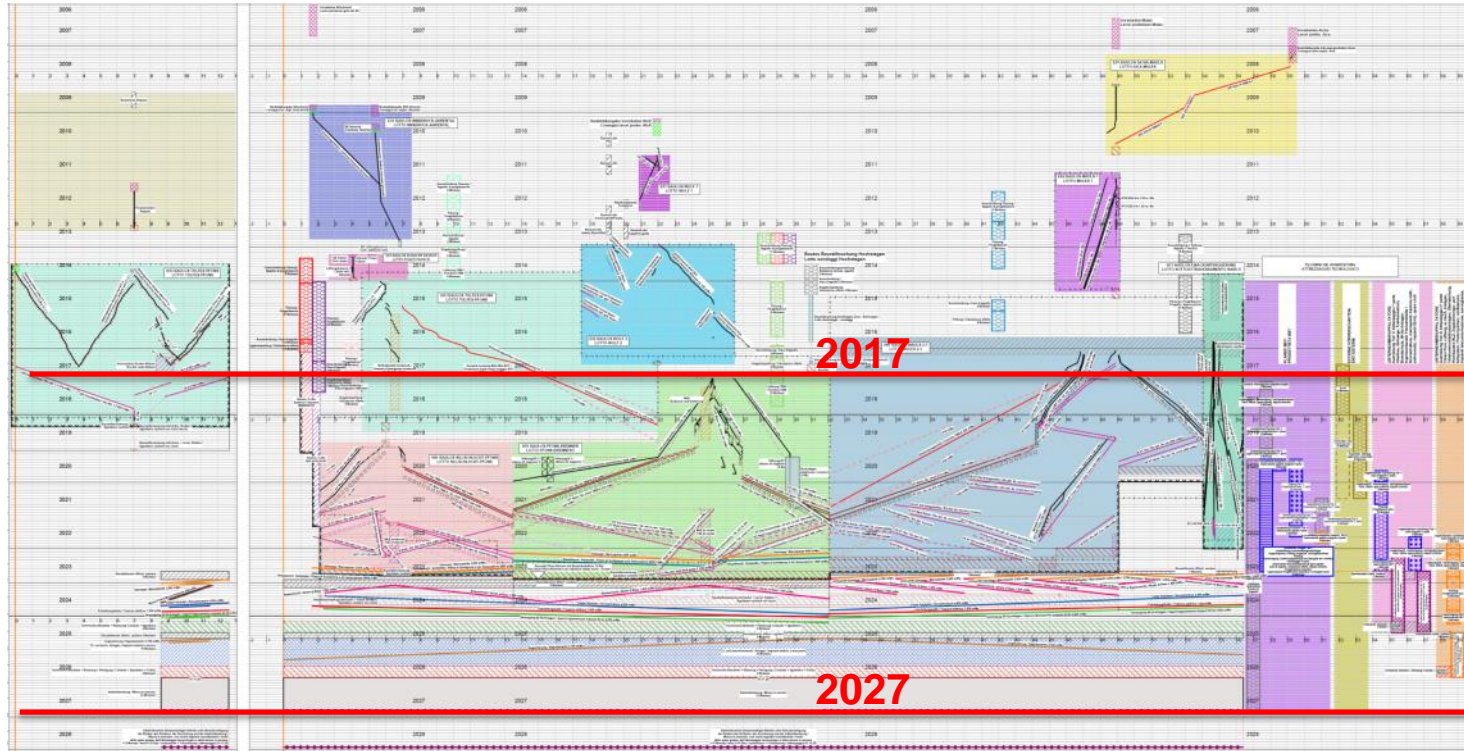

COSTO GLOBALE DELL'OPERA

DIE GESAMTKOSTEN

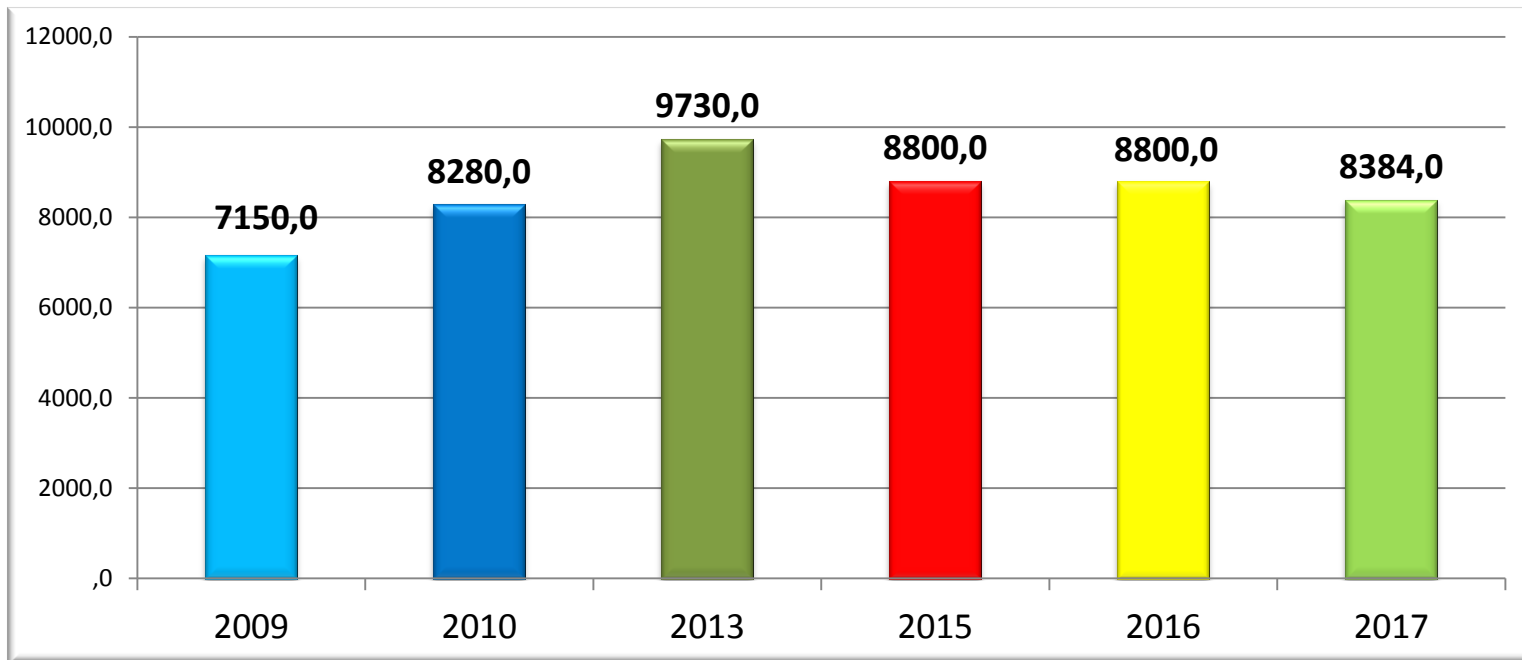

Aggiornamento costo del progetto / Update der Projektkosten (Fonte / Quelle: CIPE, Mio EUR)

I FINANZIAMENTI

DIE FINANZIERUNG



Totale contributi ad oggi garantiti:

3,321 mrd. Euro

bis heute garantite Finanzierung

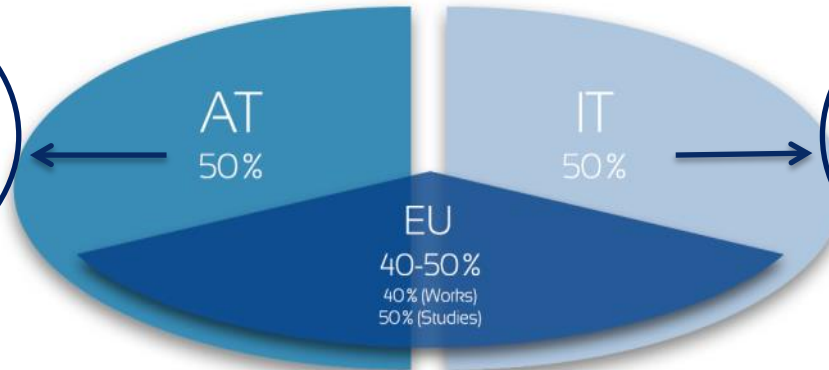

Totale contributi ad oggi garantiti:

3,029 mrd. Euro

bis heute garantite Finanzierung



STATO DI AVANZAMENTO DER BAUFORTSCHRITT

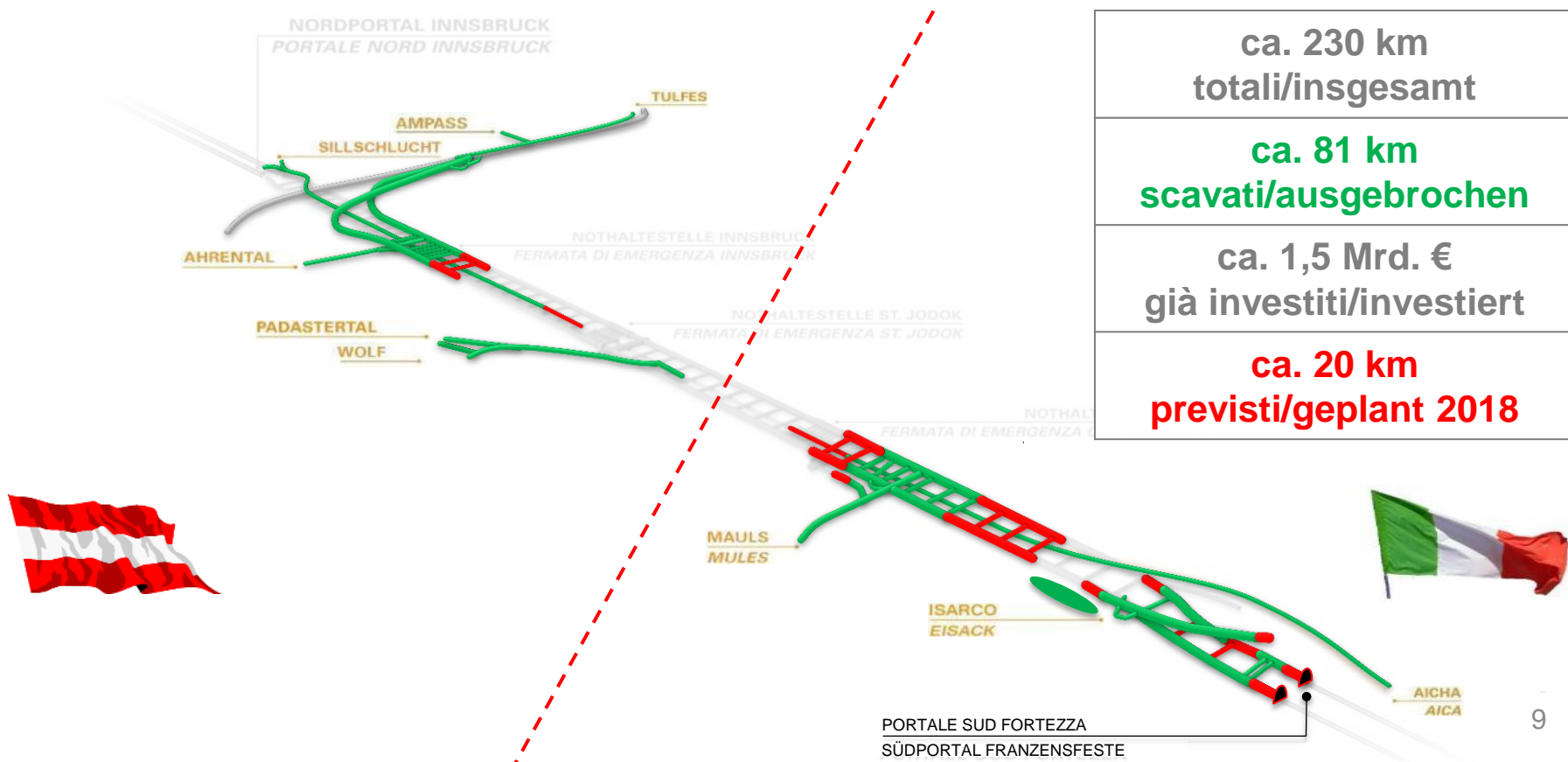

PORTALE SUD FORTEZZA
SÜDPORTAL FRANZENSFESTE

PORTALE SUD A FORTEZZA

DAS SÜDPORTAL IN FRANZENSFESTE



SOTTOATTRAVERSAMENTO ISARCO

DIE EISACKUNTERQUERUNG

AVANZAMENTO ECONOMICO **23%**



Gallerie di linea
Haupttunnel
4,5 km

Gallerie di
interconnessione
Verbindungs-
tunnel
1,2 km

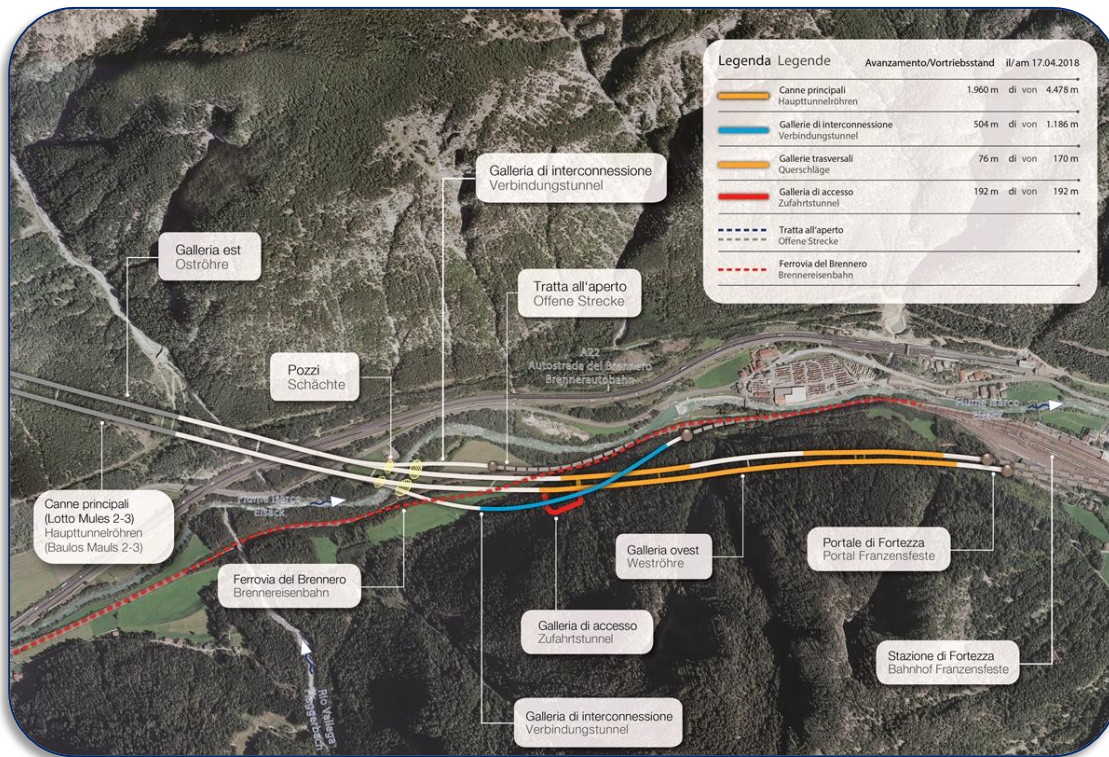

SOTTOATTRAVERSAMENTO ISARCO

DIE EISACKUNTERQUERUNG



POZZI SOTTOATTRAVERSAMENTO

- ***Completamento consolidamenti
05/2018***
- ***Completamento scavo
03/2019***
- ***Congelamento terreni e
sottoattraversamento Isarco
dal 06/2019 al 01/2021***

SOTTOATTRAVERSAMENTO ISARCO

DIE EISACKUNTERQUERUNG



GALLERIE NATURALI

- ***2664 m scavati su 6412
(al 10/04/2018, pari al 42%)***
- ***Gallerie in roccia 55%***
- ***Gallerie in detrito 45%***
- ***15 diverse sezioni di scavo
e consolidamento***

SOTTOATTRAVERSAMENTO ISARCO

DIE EISACKUNTERQUERUNG



ALTRE OPERE

Imbocco Sud per accesso stazione di Fortezza

Abbattimento diaframma 12/2018



Sistemazione fondo alveo Isarco e viabilità di emergenza



SOTTOATTRAVERSAMENTO ISARCO

DIE EISACKUNTERQUERUNG



PROSEGUIMENTO ATTIVITA'

- Inizio attività scavo gallerie Nord 09/2018***
- Abbattimento diaframma imbocco Sud 12/2018***
- Ultimazione preparazione pozzi 04/2019***
- Inizio attività congelamento terreni 06/2019***
- Fine attività costruzione opere civili 12/2022***

LOTTO MULES 2-3

DAS BAULOS MAULS 2-3

9%



Gallerie di linea
Haupttunnel
39,8 km

Cunicolo
esplorativo
Erkundungsstollen
14,8 km

Altre gallerie
Andere Tunnel
10,2 km

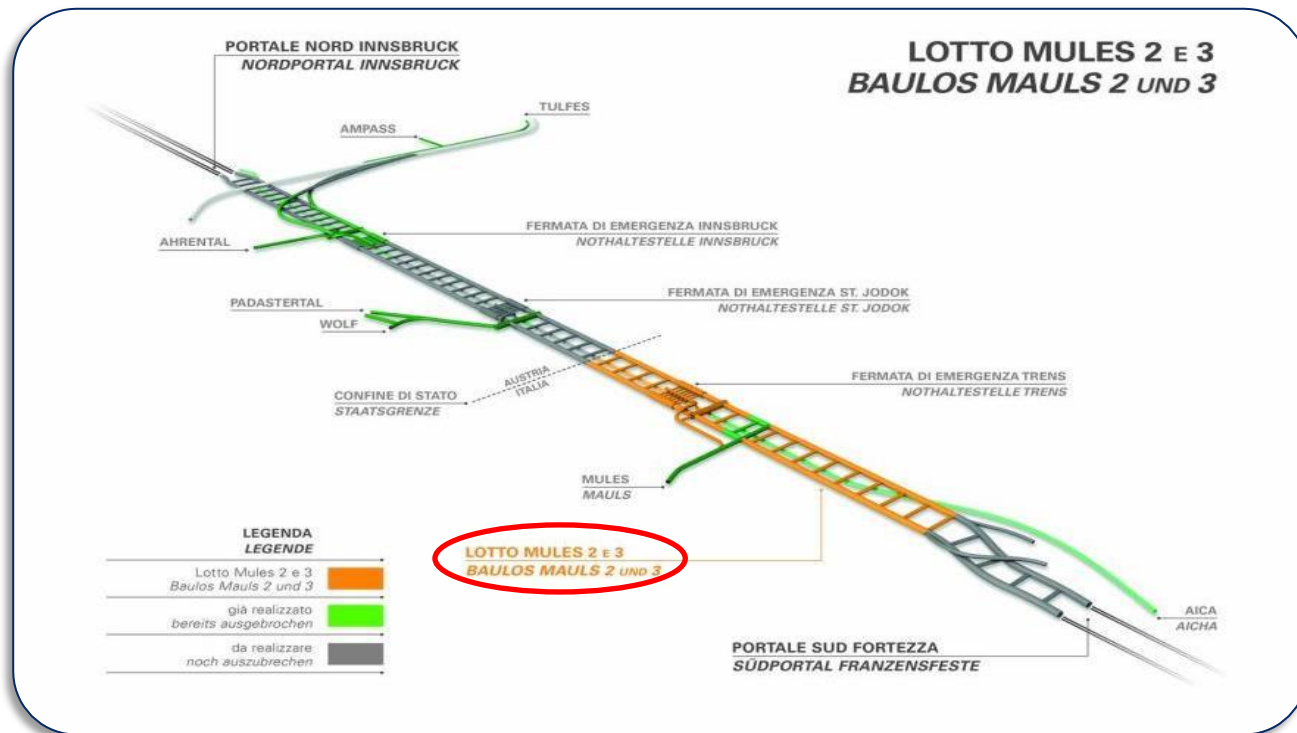

LOTTO MULES 2-3

DAS BAULOS MAULS 2-3

9%

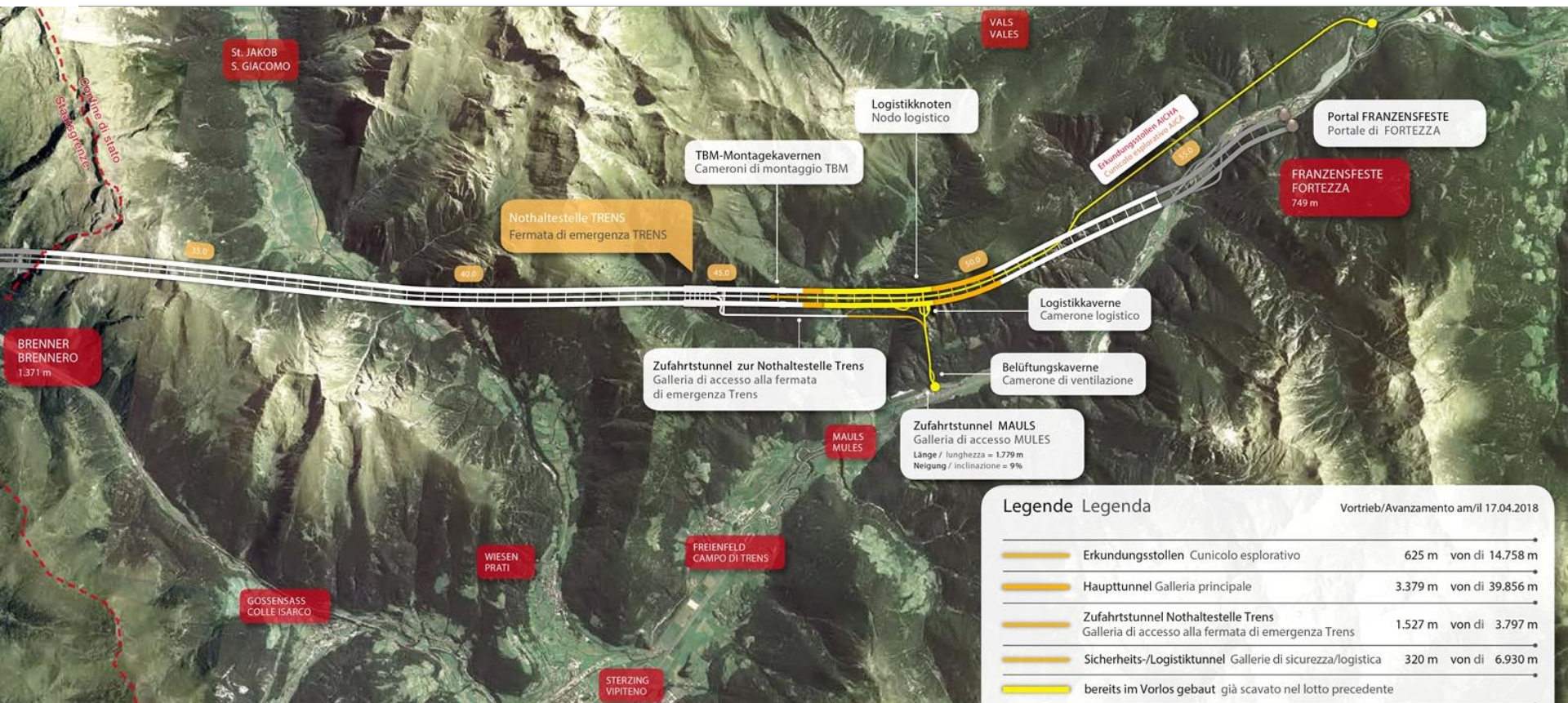

Legende **Legenda**

Vortrieb/Avanzamento am/il 17.04.2018

	Erkundungsstollen Cunicolo esplorativo	625 m	von di 14.758 m
	Haupttunnel Galleria principale	3.379 m	von di 39.856 m
	Zufahrtstunnel Notthaltestelle Trens Galleria di accesso alla fermata di emergenza Trens	1.527 m	von di 3.797 m
	Sicherheits-/Logistikstollen Gallerie di sicurezza/logistica	320 m	von di 6.930 m
	bereits im Vorlos gebaut già scavato nel lotto precedente		

LOTTO MULES 2-3: PROSSIME ATTIVITÀ

BAULOS MAULS 2-3: ANSTEHENDE AKTIVITÄTEN



- **26.04.2018**
Avvio della TBM «Serena»
Start der TBM «Serena»
 - produzioni attese per i primi mesi di 200 m/mese
 - *Vortrieb in den ersten Wochen 200 m/Monat*



LOTTO MULES 2-3: PROSSIME ATTIVITÀ

BAULOS MAULS 2-3: ANSTEHENDE AKTIVITÄTEN



- Scavo verso nord fino ai **Cameroni di montaggio TBM** delle gallerie di linea, il cui inizio scavo è previsto entro fine giugno 2018. Inizio scavo con TBM: **fine gennaio 2019**
- *Vortrieb in Richtung Norden, bis zu den **TBM-Montagekavernen der Hauptröhren**, die ab Ende Juni gebaut werden. Start des Vortriebs mit TBM: **Ende Januar 2019***



LOTTO MULES 2-3: PROSSIME ATTIVITÀ

BAULOS MAULS 2-3: ANSTEHENDE AKTIVITÄTEN



- Proseguimento degli scavi per le gallerie di linea verso sud in granito
- *Fortsetzung des Vortriebs der Hauptröhren in Richtung Süden, in Granit*
- Iniziatò lo scavo della Galleria di accesso alla FDE all'interno della Faglia Periadriatica. Durata: 18 mesi
- *Beginn des Vortriebs des Zufahrtstunnels zur NHS im Bereich der Periadriatischen Naht. Dauer: 18 Monate*



ALTRI INTERVENTI NELL'AREA DI PROGETTO

WEITERE MASSNAHMEN IM PROJEKTGEBIET



1) Misure di compensazione / Ausgleichsmaßnahmen	50.000.000 €
> Interventi costruttivi accompagnatori	
> Begleitende Baumassnahmen	
2) Misure di mitigazione / Schutzmaßnahmen	6.100.000 €
> Mitigazione dei disturbi generati dalle attività di cantiere	
> Minderung der Störungen durch Baustellentätigkeiten	

ALTRI INTERVENTI NELL'AREA DI PROGETTO

WEITERE MASSNAHMEN IM PROJEKTGEBIET

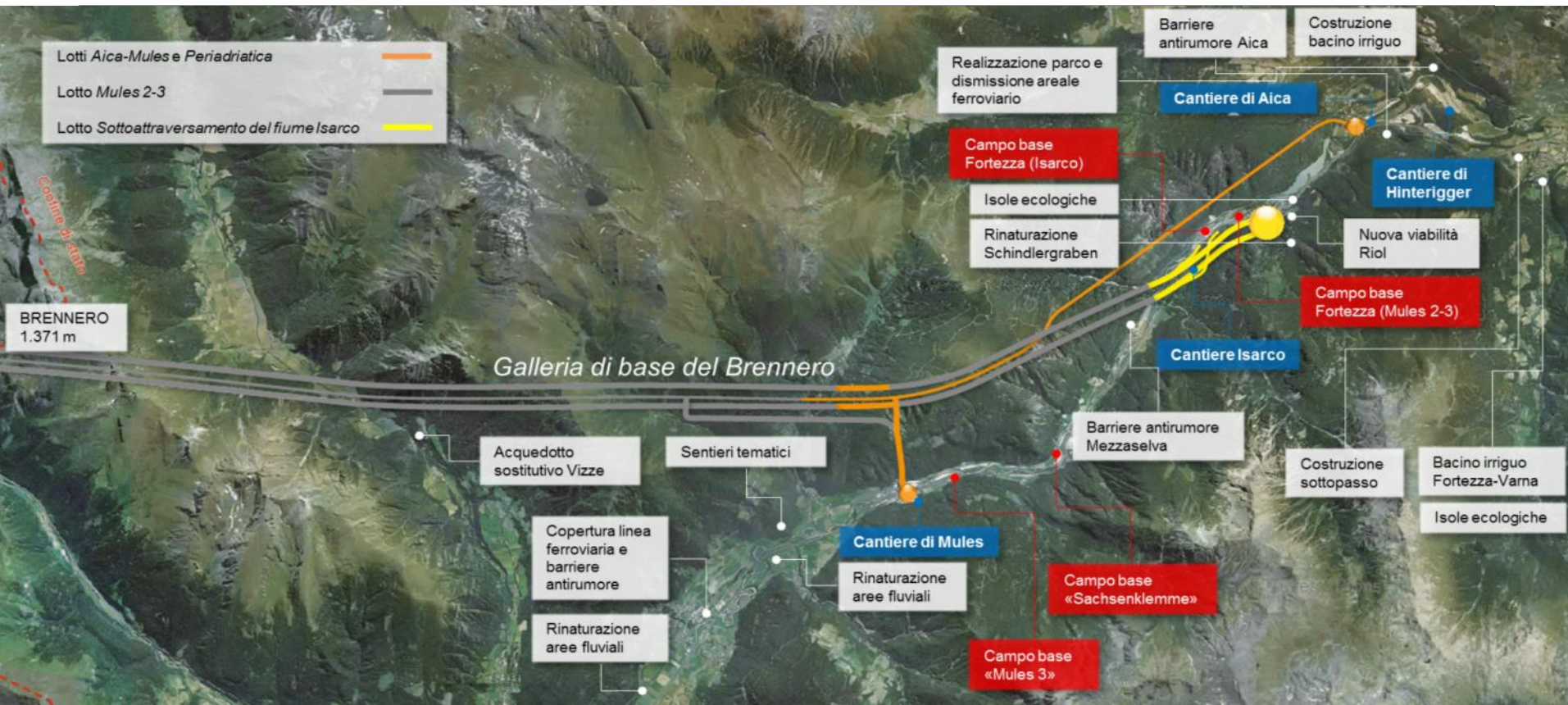

CONTRATTI DAL 2007

DIE VERTRÄGE SEIT 2007



Importo **complessivo** / Gesamtbetrag:
€ 2.247.173.501,55



- **Contratti affidati a Joint Venture comprendenti imprese locali / An lokale Unternehmen (auch in Form von BG) vergebene Verträge**
- **Contratti affidati ad altre Joint Venture / An Dritte vergebene Verträge**

PERSONALE IMPIEGATO

DAS ANGESTELLTE PERSONAL

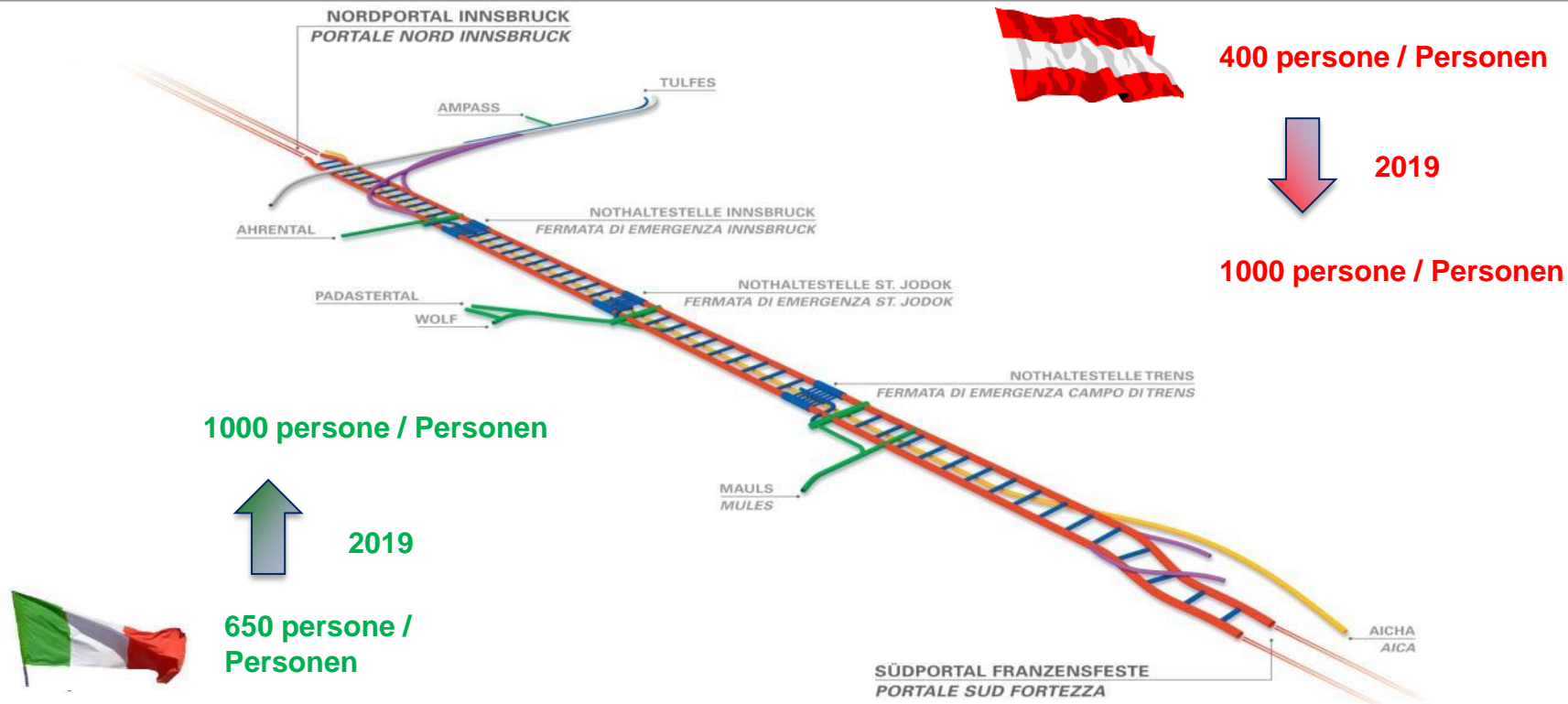

DATI STATISTICI SUGLI INFORTUNI: CONFRONTO CON OPERE ANALOGHE



Indice di frequenza sugli infortuni

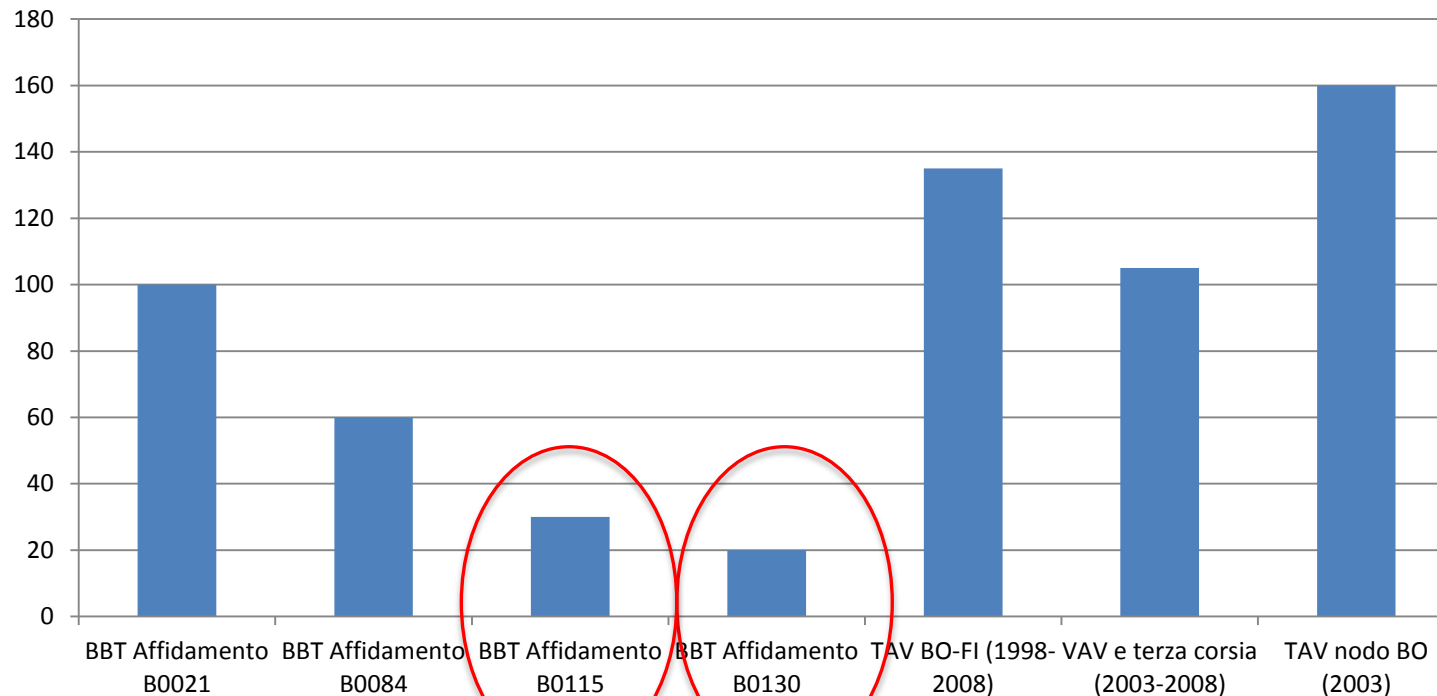

DATI STATISTICI SUGLI INFORTUNI: CONFRONTO CON OPERE ANALOGHE



Indice di gravità degli infortuni

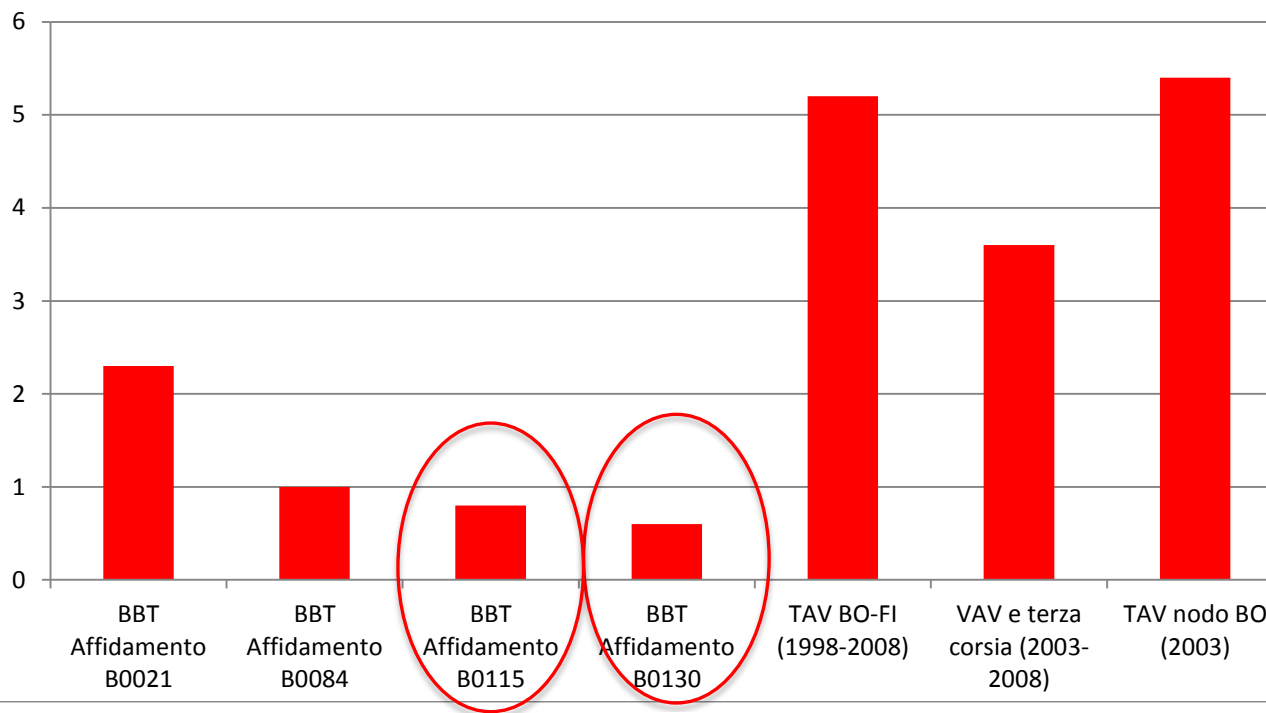

PROGETTO SCUOLA *DAS SCHULPROJEKT*



ca. 30 stagisti/anno
ca. 30 Praktikanten/Jahr

COMUNICAZIONE

DIE KOMMUNIKATION



- Incontri informativi
*Informations-
veranstaltungen*



- Infopoints

Steinach a. B.
Franzensfeste /
Fortezza



- Visite alla galleria *Tunnelführungen*



- Pubblicazioni annuali
Publikationen
- Osservatorio ambientale
Beobachtungsstelle
- Fiere ed eventi
Messen und Events
- Scuole ed università
Schulen und Universitäten

- Sito web / Webseite:
www.bbt-se.com



**DANKE FÜR IHRE AUFMERKSAMKEIT!
GLÜCK AUF!
*GRAZIE DELL'ATTENZIONE!***



Von der Europäischen Union kofinanziert
Fazilität „Connecting Europe“
*Cofinanziato dall'Unione europea
Meccanismo per collegare l'Europa*